



# TAVOLONE

Series

**Features:**

- Includes fully adjustable drawersliders
- Fully finished interiors
- Includes installation hardware
- Micro-Density Fiberboard (MDF) construction
- PVC finish resists moisture and scratches

Side view for plumbing

Back view for plumbing

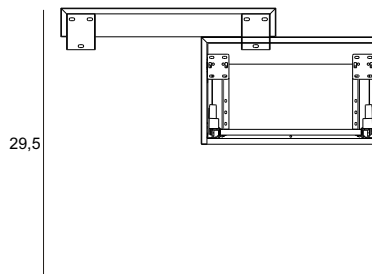
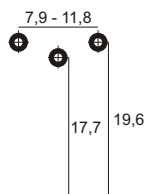
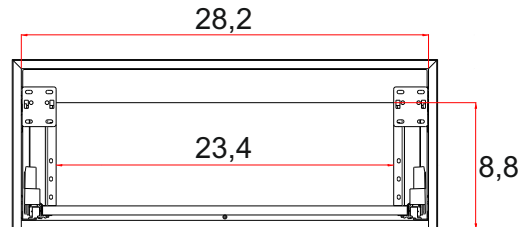
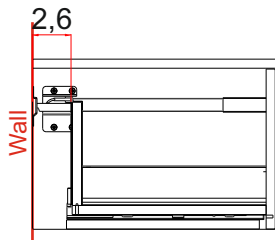
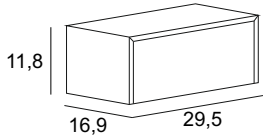
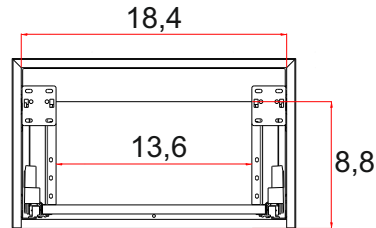
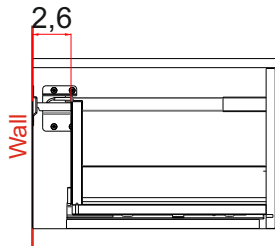
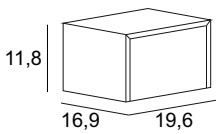
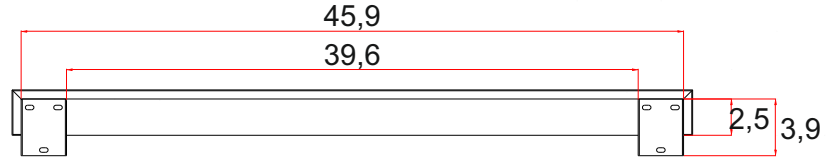
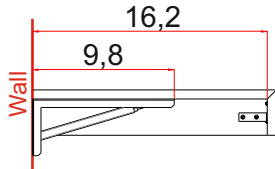
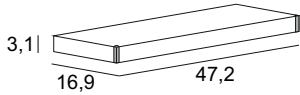
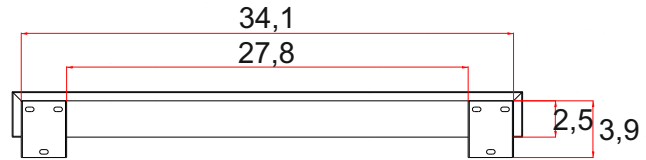
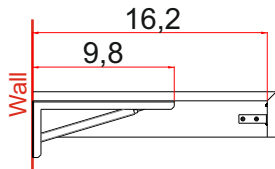
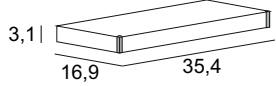
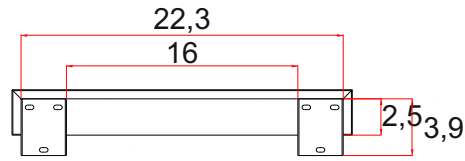
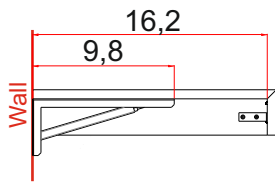
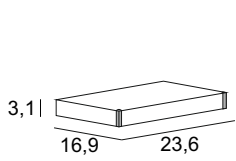

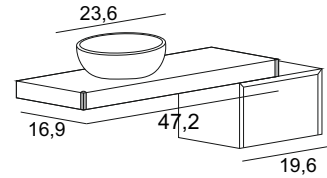
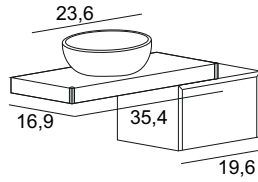
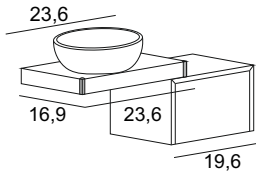

**Basins available:**  
 - ceramic

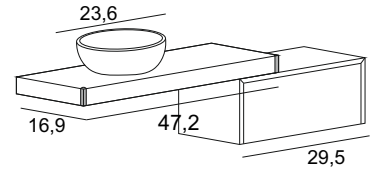
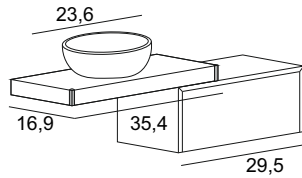
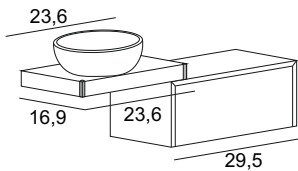

## FURNITURE CHARACTERISTIC



Cabinet in MDF, sides thickness 0,62in, coated in PVC 0,01in waterproof and scratchproof that guarantee long life and reliability.



Soft closing hinges guaranteed for 100,000 cycles. Soft closing slides guaranteed for 60,000 cycles. Hinges and slides used in furniture and complementary allow the adjustment in 3 different positions.



Ceramic washbasin resistant to high temperature and impacts.



It is not necessary to assemble the cabinet (product not in kit).

## MIRRORS



Mirror lighting full-led, guarantee an energy saving of a 80/90% compared to a classic lighting incandescent or halogen and life of about 3/5 times higher.



The LED lighting can exceed 50.000 hours of activities, reducing the costs of maintenance. Not produce heat and withstand the high temperatures.  
 IP44 ☐ CE



Unlike normal halogen lamps, do not contain mercury and do not emit harmful UV rays for the health.

**Installation notes:**

Install this product according to the installation guide  
 Special site preparation is required.

Wall bracing and Baden Haus supplied hardware are recommended.

The plumbing must be roughed into the plumbing cutout area of the vanity.

Refer to the sink rough-in and the vanity rough-in for proper placement. The water supply and drain lines must be installed before installing the vanity.

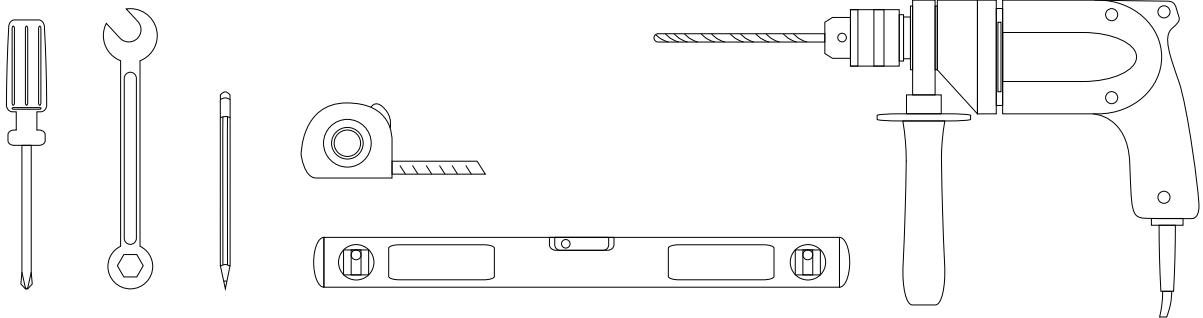
**Installation tools not included:**

**Materials Included:**

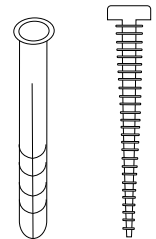
6 short nylon rawlplug  
 6 short screws

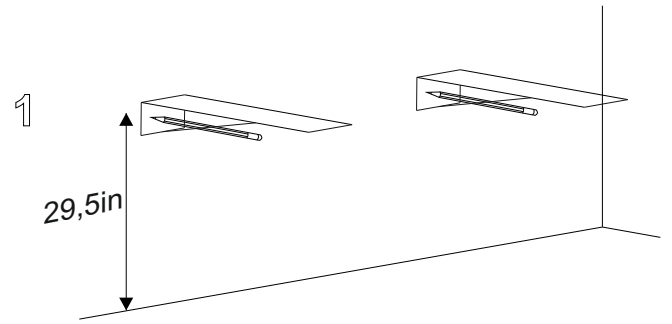

**X6**
**X6**

**Step 1**

Mark on the wall the hole locations to fix the brackets.

**Step 2**

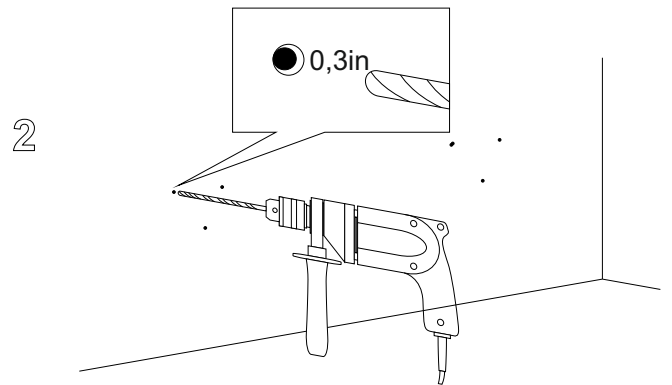
Make holes according the positions taken in step 1.

**Step 3**

Insert the nylon rawplugs inside holes.

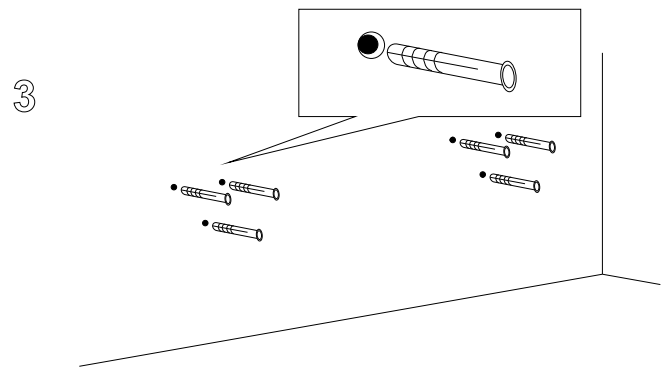
**Step 4**

Using the supplied screws, fix strongly the brackets on the wall.

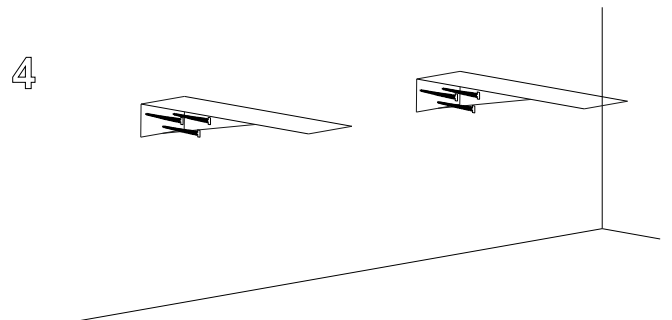
**Step 5**

Lean the wooden panel above the brackets.

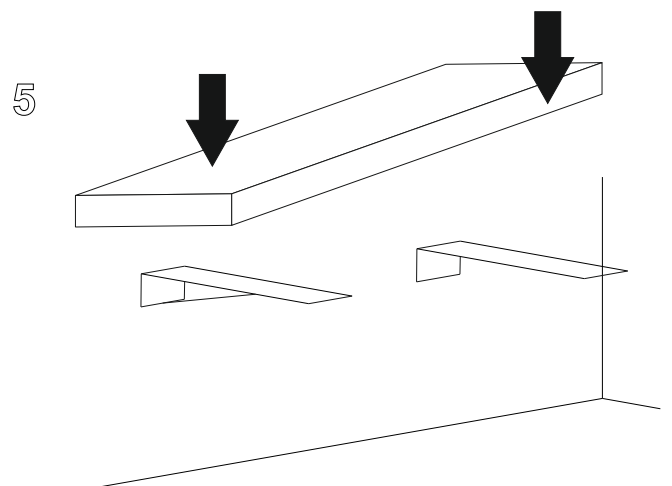



**TAVOLONE**  
Series

**Step 6**

Using the supplied screws, fix the wooden panel with the brackets.

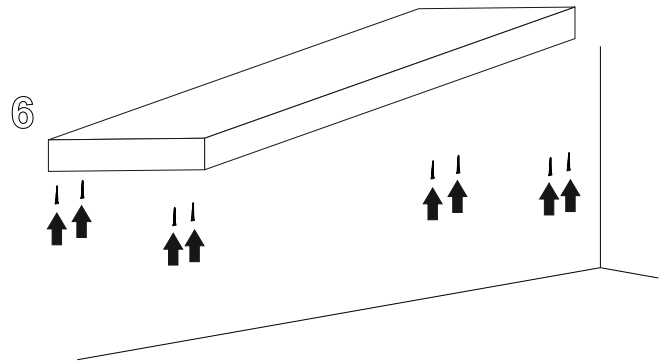

**Installation notes:**

Faucet and silicone are not included.  
 All sizes are subject to tolerance.

**Sink assembly**

Install the faucet to the top and drains to the sink. Refer to the faucet and drain manufacturer's instructions.  
 Complete the faucet connections. Run water and check for leaks.  
 Apply a bead of silicone behind the top surface to the finished wall.

**CERAMIC BASIN ART. 50179**

Top view of sink

