

**Installation notes:**

Faucet and silicone are not included.  
 All sizes are subject to tolerance.

**Sink assembly**

Install the faucet to the top and drains to the sink. Refer to the faucet and drain manufacturer's instructions.  
 Complete the faucet connections. Run water and check for leaks.  
 Apply a bead of silicone behind the top surface to the finished wall.

**RESIN BASIN ART. 50140**

Top view of sink

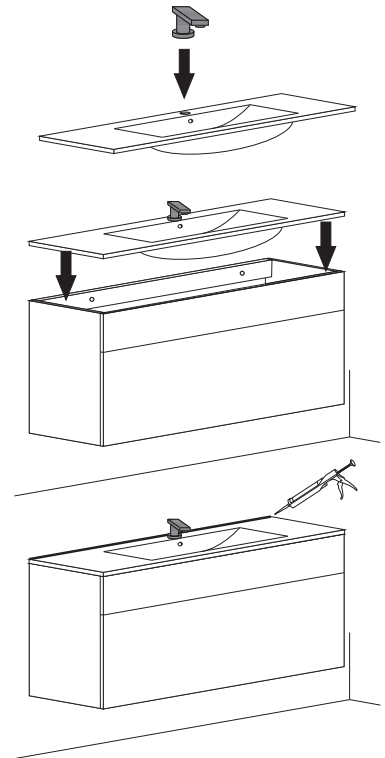
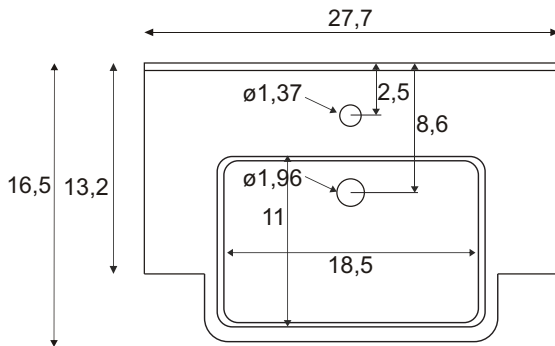
**RESIN BASIN ART. 50141**

Top view of sink

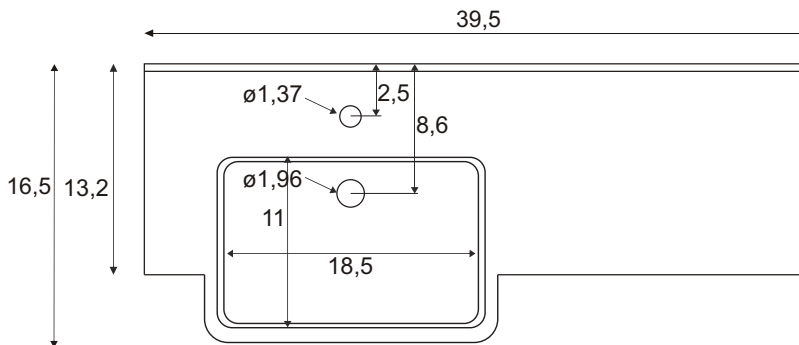
**RESIN BASIN ART. 50144**

Top view of sink

