

## **SIDLER Diamando 3 / 47<sup>1</sup>/<sub>4</sub>"**

**none electric**

Cabinets available with a left, a right and a central door

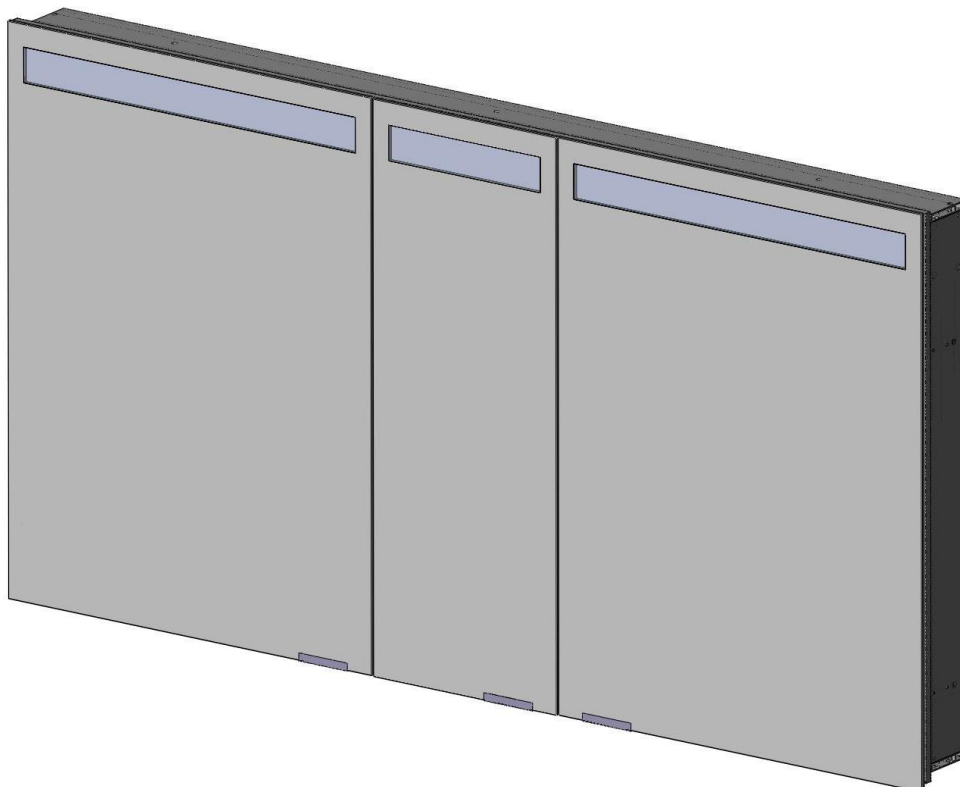

**Please read instructions before proceeding**

**Save these instructions**

**IMPORTANT SAFETY INSTRUCTIONS – to reduce the risk of burns, fire, electric shock, or injury:**

- This product is for household use only.
- The maximum load is 1.5kg (3lbs) per glass shelve.
- **WARNING – do not use outdoors.**
- **WARNING – use this furnishing only for its intended use as described in these instructions.**
- **WARNING – never operate the furnishing with the air openings blocked. Keep the air openings free of lint, hair, and the like.**
- **WARNING – never drop or insert any object into any opening.**
- **WARNING – avoid dispensing of aerosol sprays near top of the cabinet**
- **When using an electrical furnishing, basic precautions should always be followed, including the following:**

**Read all instructions before using (this furnishing)**









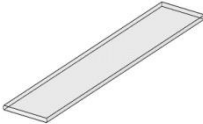
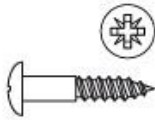

- **DANGER – To reduce the risk of electric shock:**

**Close supervision is necessary when this furnishing is used by, or near children, invalids, or disabled persons**

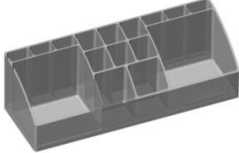
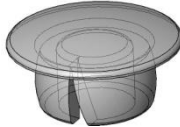
- **SAVE THESE INSTRUCTIONS**

**List of all components to be installed**

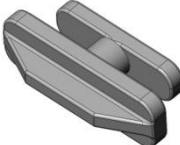
Pos.	Pcs.	Description	Dimension [mm]	Comment
1	3	mirror door		
2	6	cover cap dampener		
3	9	glass shelf		
4	4	screw	Ø4.5 x 35	
5	1	cosmetic mirror		
6	1	cosmetic box		
7	2	transparent cover		
8	3	plastic inlay		
9	6	dampener		
10	6	bump stop		
11	18	slider		spare part
12	18	shelve holder		spare part

			
pos. 1 Mirror door	pos. 2 Cover cap dampener	pos. 3 Glass shelf	pos. 4 Screw
			
pos. 5 Cosmetic mirror	pos. 6 Cosmetic box	pos. 7 Transparent cover	pos. 8 Plastic inlay
			
pos. 9 Dampener	pos. 10 Bump stop	pos. 11 Slider	pos. 12 Shelve holder

## Installation Guide

### Step 1 – Remove the mirror doors

- 1) Remove the doors (Pos.1) from the cabinet by pressing clip C.

**!Attention!**

**Do properly hold the door before pushing clip C  
Handle door carefully**

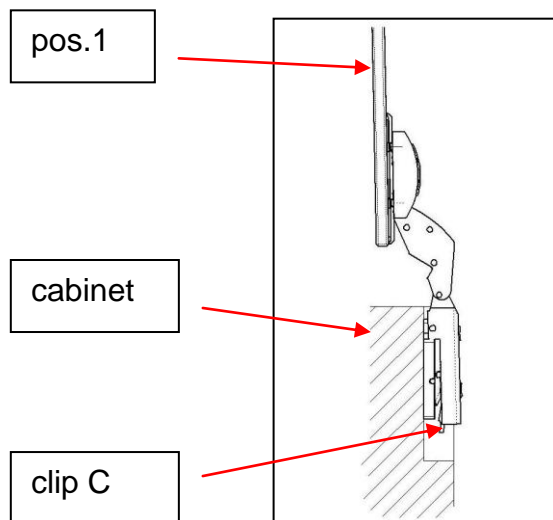

## Step 2 – Remove the Electrical Cover

- 1) Remove light cover A carefull by hands.

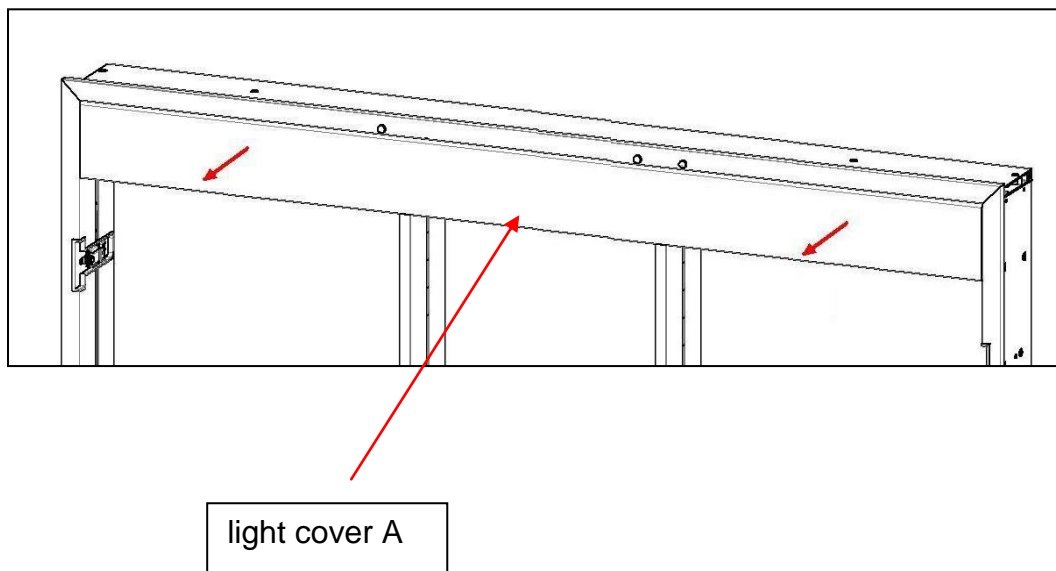

- 2) Remove fluorescent tube

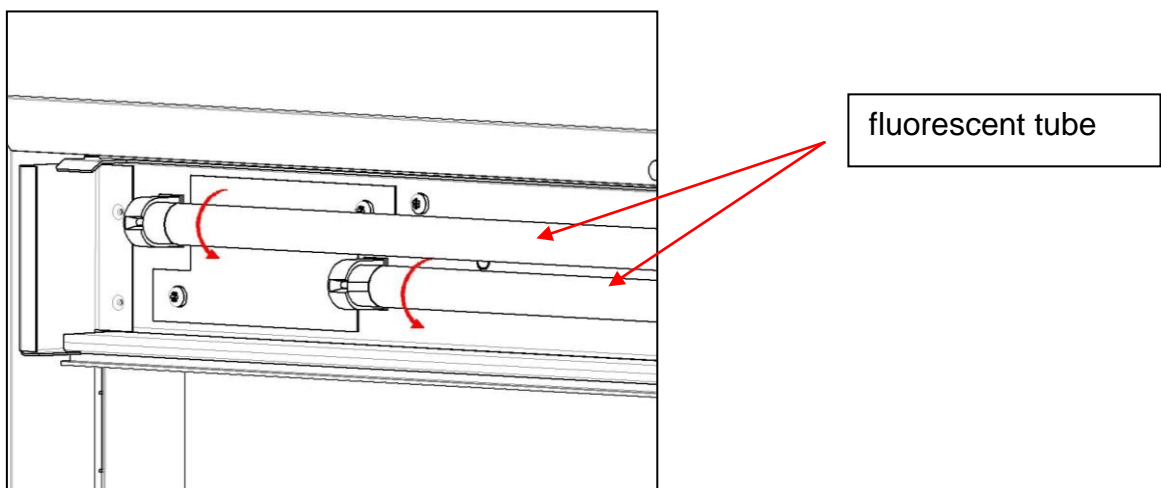

3) Loosen the screws marked with a B

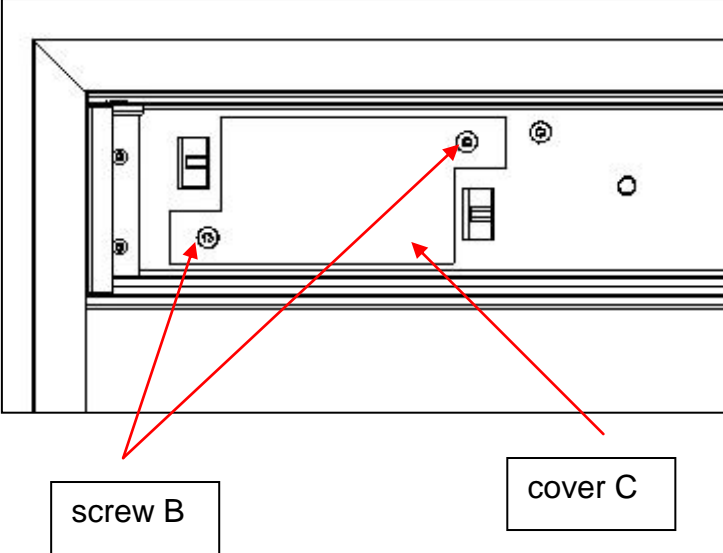

4) Remove cover C to get access to the terminal block

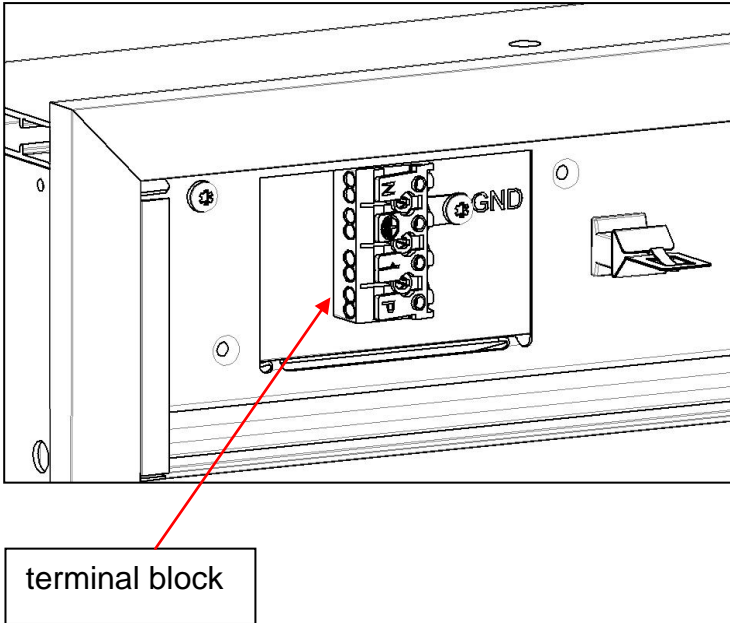

## Step 3 – surface mount

- 1) Use **wall mount kit** including side mirrors (see separate Operating Instruction *wall mount kit for Diamando 3 / 47 1/4"*) if cabinet will be wall mounted.

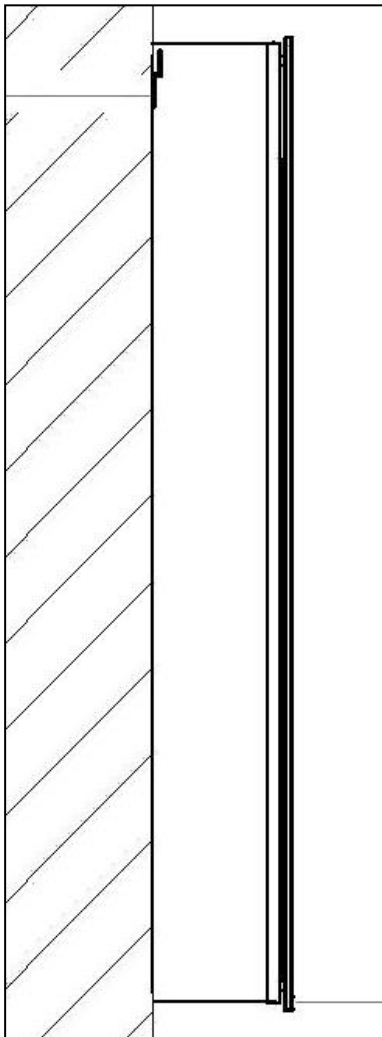

2) Proceed with step 4 if cabinet will be recessed.

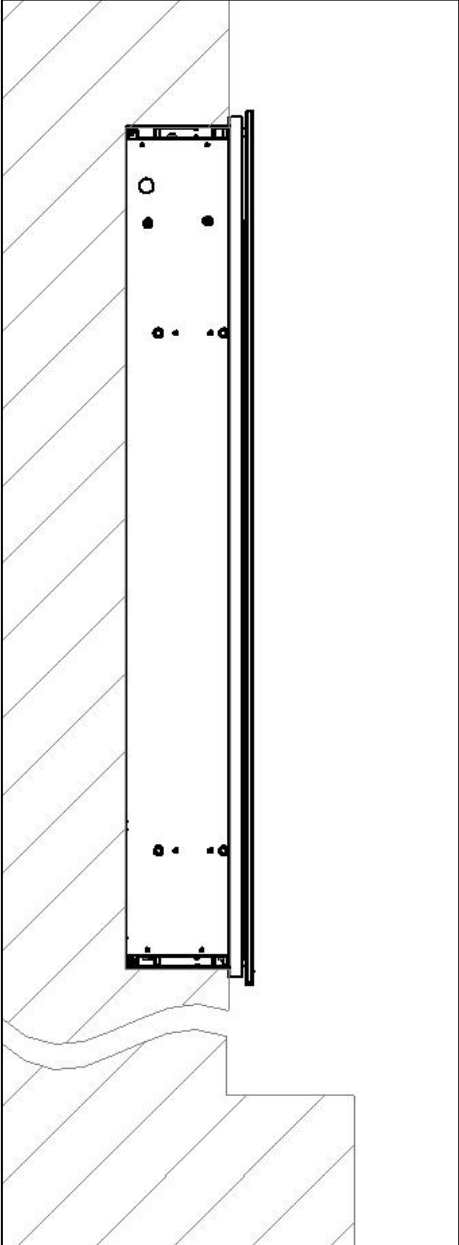



## Step 4 –recessed mount cabinet

- 1) Thread the wires in the side opening to provide connection in Step 4.

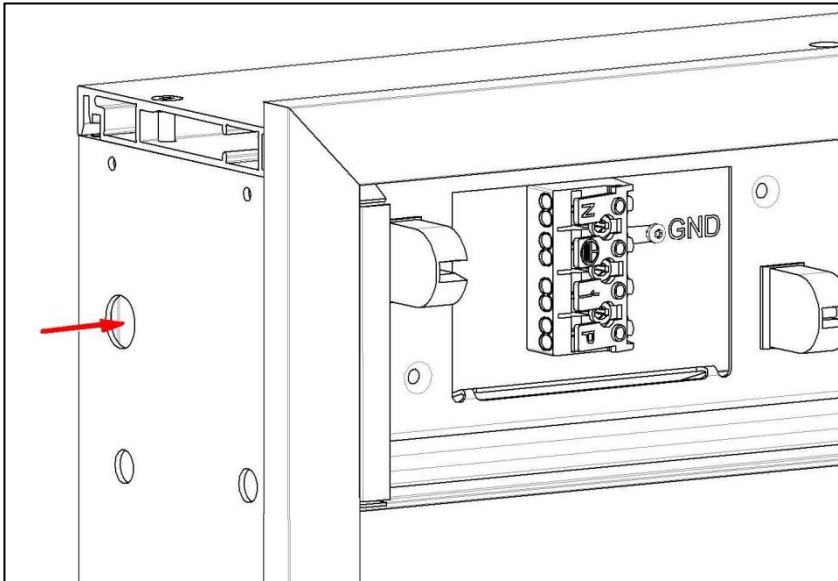

- 2) Place the cabinet in the provided opening 46.5" x 30.75" which is surrounded by 2" x 4" studs.
- 3) If the cabinet does not fit in to the provided opening, do rework on the opening and studs until cabinet fits.

4) Tighten the screws on provided openings

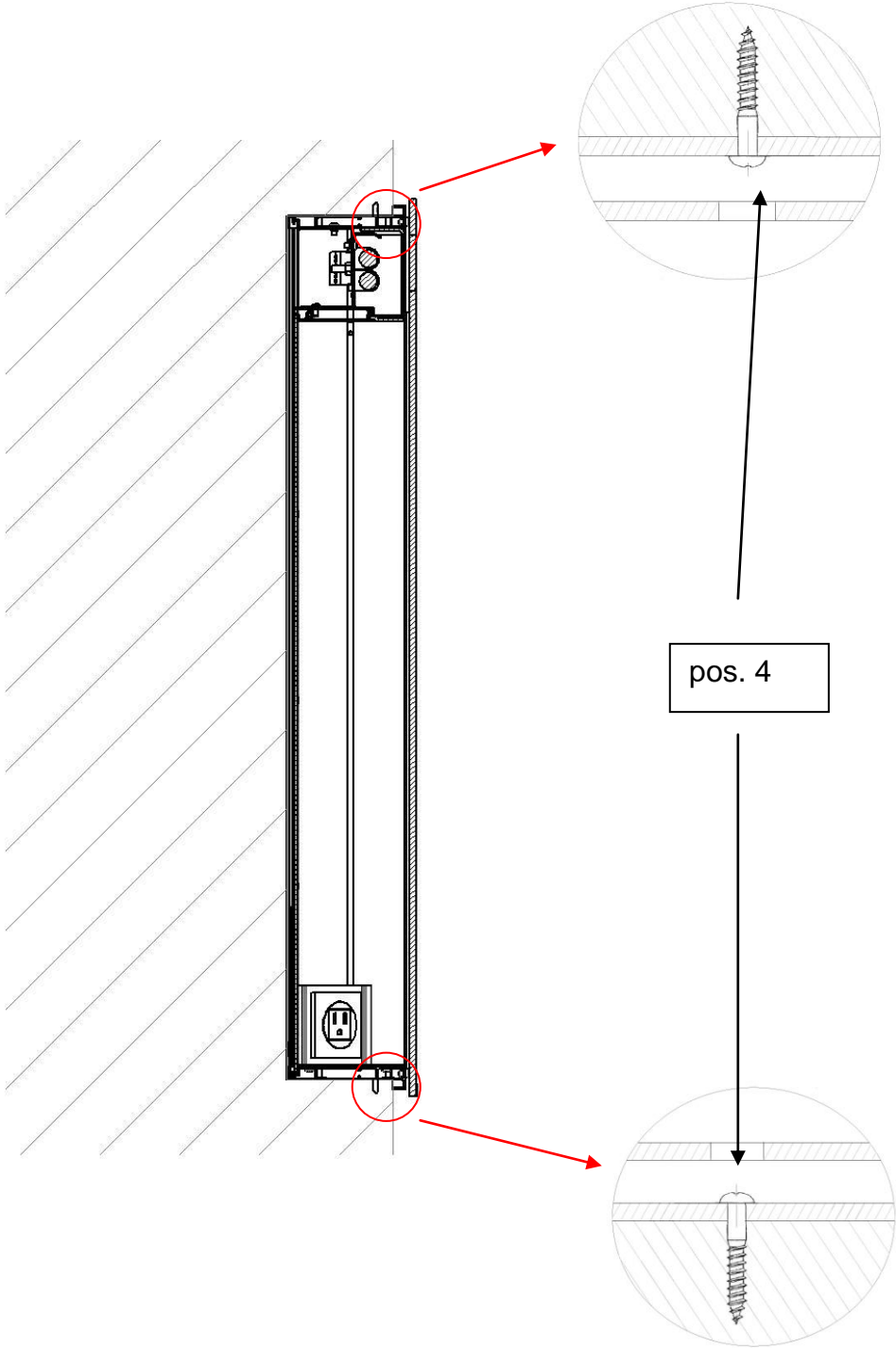

## Step 5 – Connect the Electric Cables

- 1) Connect all cables (live, phase, neutral and earth) in accordance with the diagram.
- 2) Replace the electrical cover which was removed during step 2.

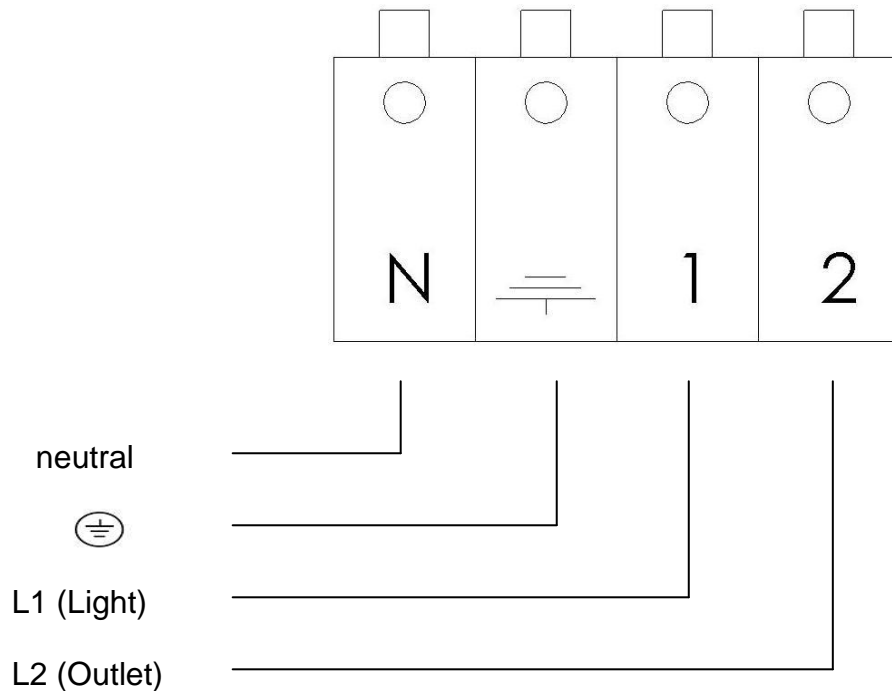

### Warning announcement:

- **Installation shall be performed by a qualified licensed electrician.**
- **Grounding instructions for a permanently connected product. This product must be connected to a ground metal, permanent wiring system, or an equipment-grounding conductor must be run with the circuit conductors and connected to the equipment-grounding terminal or lead on the product.**
- **Wired to a separate 120V ac, 15A GFCI circuit breaker to comply with the National Electrical Code shall be provided**

## Step 6 – Doors

- 1) Remove the hinges from the cabinet by pressing clip C.

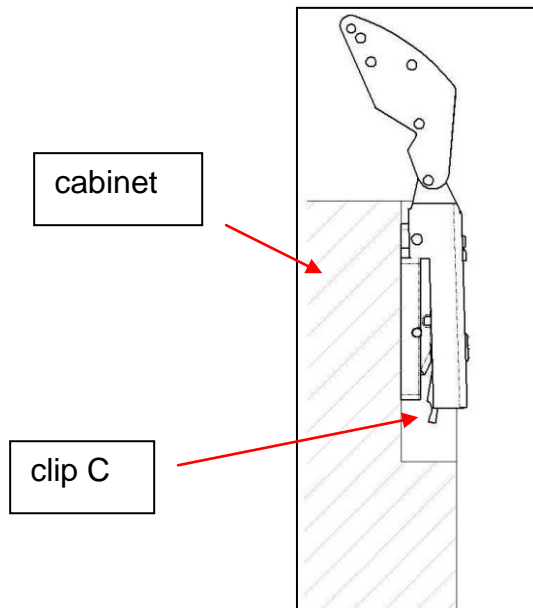

- 2) Place the hinges on the doors (pos. 1).

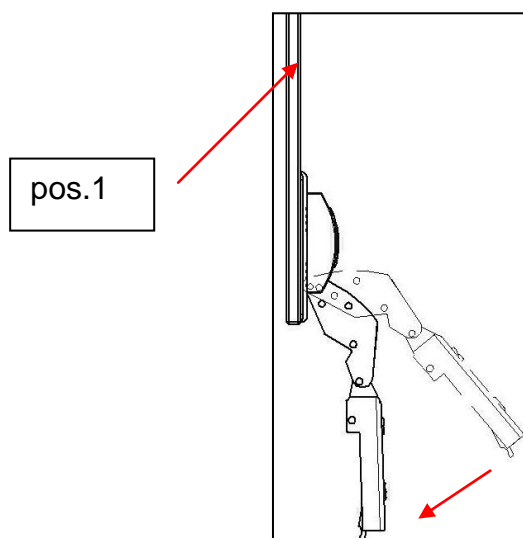

3) Hang the doors on the hinges (pos. 1).

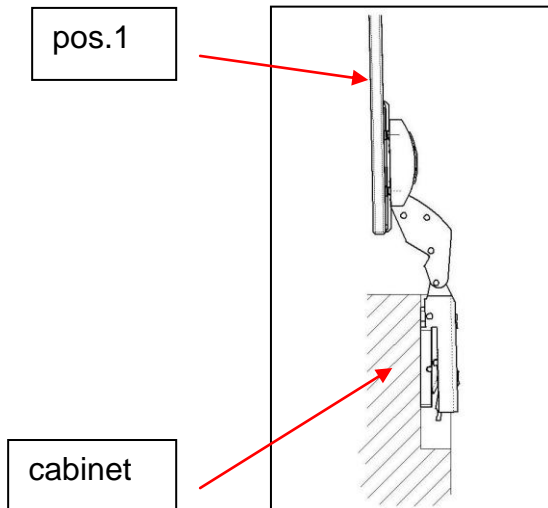

4) Align the doors (pos. 1) on the hinges (see diagram for adjustment possibilities).

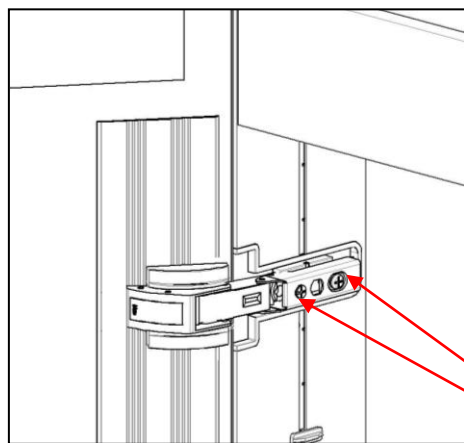

adjust the door with this screw

- 5) Place the cover cap on the door dampeners (pos. 2) and attach the door dampeners (pos. 9) to the hinges.

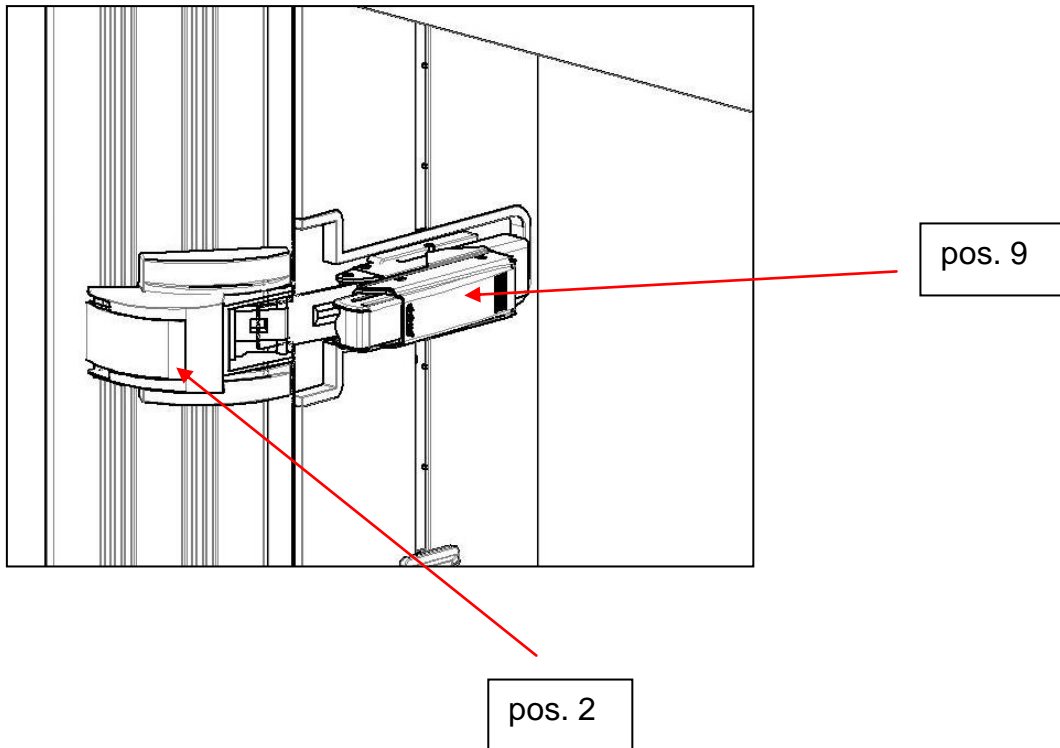

## Step 7 – Final Assembly

- 1) Place the plastic inlay (pos. 8) in the lower tray.
- 2) Push the bump stops (pos. 10) into the holes provided.
- 3) Push the Transparent cover (pos. 7) into the holes provided

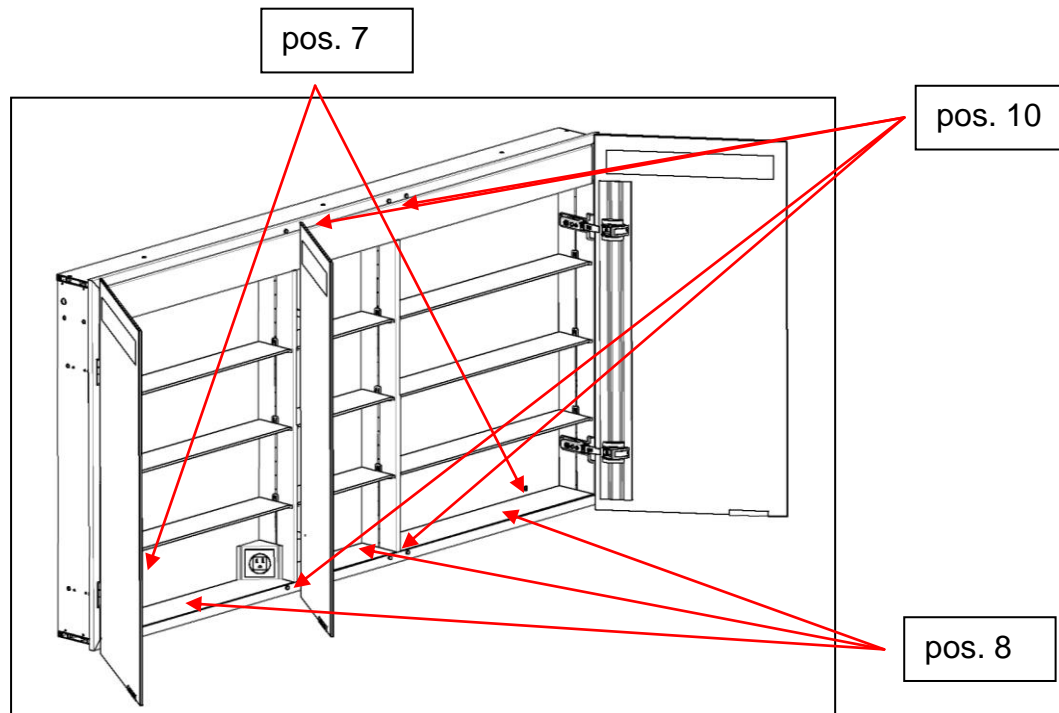

- 4) Remove the shelf holder (pos. 12) by pulling it upwards.

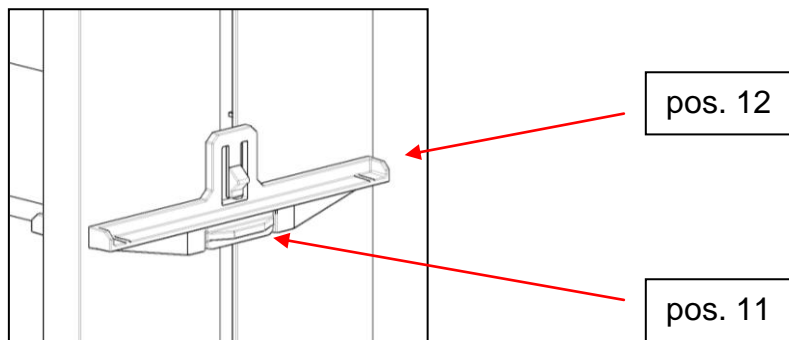

- 5) Turn the slider (pos. 11) 90° and position it at the desired height. Turn the slider (pos. 11) 90° once more to set it in this position.

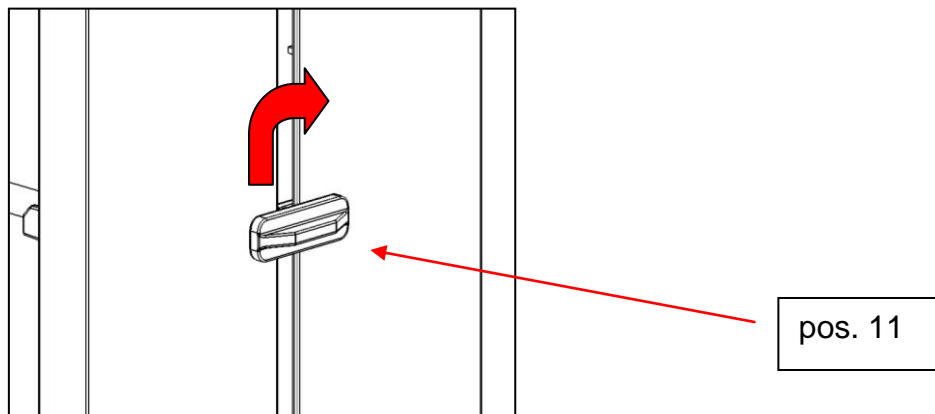

- 6) Place the glass shelf (pos. 3) into the shelf holder. Glass shelf (pos. 3) must always be positioned horizontally!

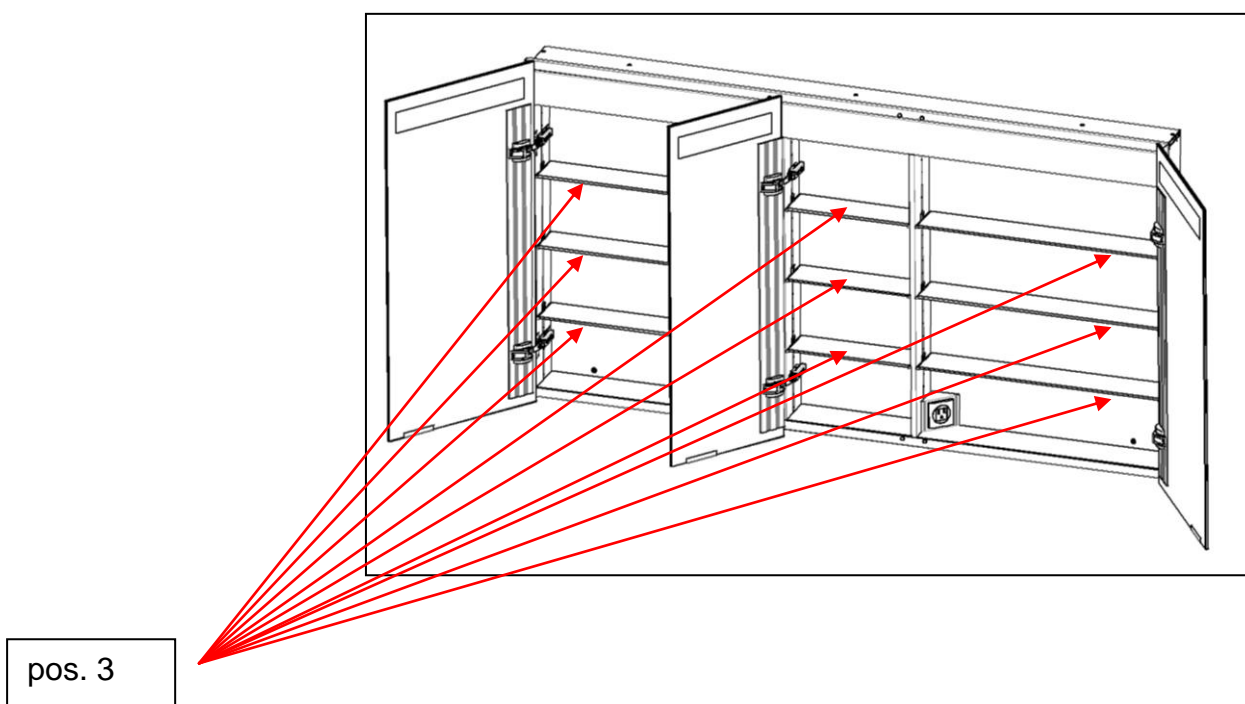



## Step 8 – Cleaning

- 1) Mount the glass cover in accordance with the diagram.  
Do not use abrasive cleaners, scrapers, metal brushes, or any items or products that could scratch or dull the surface.  
Do not allow the surface to come into contact with products such as acetone (nail polish remover), dry cleaning solution, lacquer thinner, gasoline, etc.

## Step 9 – Cosmetic Box and Cosmetic Mirror

The cosmetic mirror (pos. 5) and the cosmetic box (pos. 6) are positioned individually by the customer.

cosmetic mirror



cosmetic box

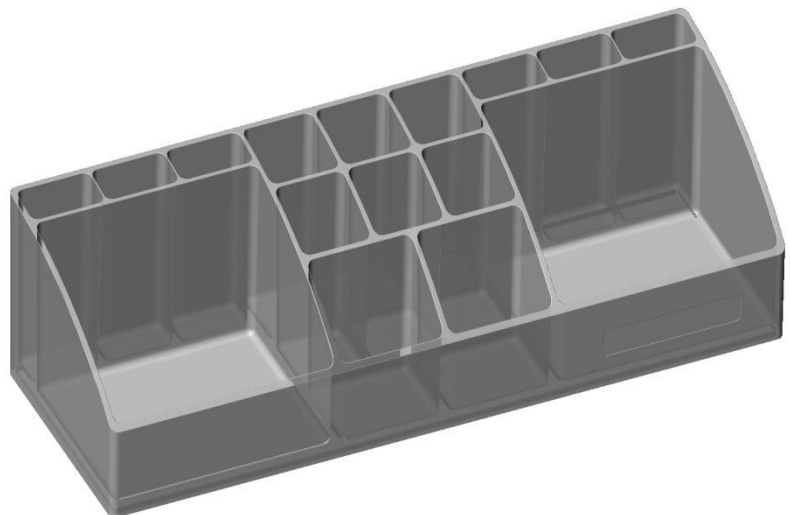

## LIMITED WARRANTY

SIDLER will provide a two-year warranty in respect of defects associated with the Product, commencing from the date of delivery, subject to the following conditions:

- ( I ) The Product must have been professionally mounted and installed by a certified licensed contractor in accordance with the *Safety Standards Act*, S.B.C. 2003, c. 39, as amended, and the Electrical Safety Regulation B.C. Reg. 100/2004, as amended.
- ( II ) The Product must have been used by the Purchaser in the manner and for the purpose recommended and authorized by SIDLER and the manufacturer.
- ( III ) The Product must not have been modified, or changed in design or function following delivery.
- ( IV ) In each case, written notice by the Purchaser specifying the alleged defects must be received during the warranty period (within two years of the date of delivery).
- ( V ) The warranty is limited to replacement parts only.
- ( VI ) Damages resulting from normal wear and tear are excluded. The determination of whether damage has so resulted will be in the sole discretion of SIDLER.
- ( VII ) Damages resulting from any errors in representations made by the manufacturer regarding product specifications are excluded.

**SIDLER International Ltd.**

#205 – 2999 Underhill  
Avenue  
Burnaby, BC V5A 3C2

Phone: (604) 415 24 22  
Toll Free: (888) 415 24 22  
Fax: (604) 415 24 33  
E-mail: [info@sidler-international.com](mailto:info@sidler-international.com)  
Homepage: [www.sidler-international.com](http://www.sidler-international.com)