

Features

- Single-function Rain showerhead.
- MasterClean™ spray nozzles prohibit mineral buildup for easy cleaning.
- Katalyst™ Spray Technology with air induction ball joint (patent pending)
- Optimized sprayface for maximum performance.
- Solid brass construction.
- 2.5 gallon (9.5 L) per minute flow rate.
- 1/2" - 14 NPT connection.



Codes/Standards







ASME A112.18.1/CSA B125.1
DOE - Energy Policy Act 1992

KOHLER® Faucet Lifetime Limited Warranty

See website for detailed warranty information.

Available Colors/Finishes

Color tiles intended for reference only.

Color	Code	Description
	CP	Polished Chrome
	SN	Vibrant® Polished Nickel
	BGD	Vibrant® Moderne Brushed Gold
	BN	Vibrant® Brushed Nickel
	BV	Vibrant® Brushed Bronze
	TT	Vibrant Titanium

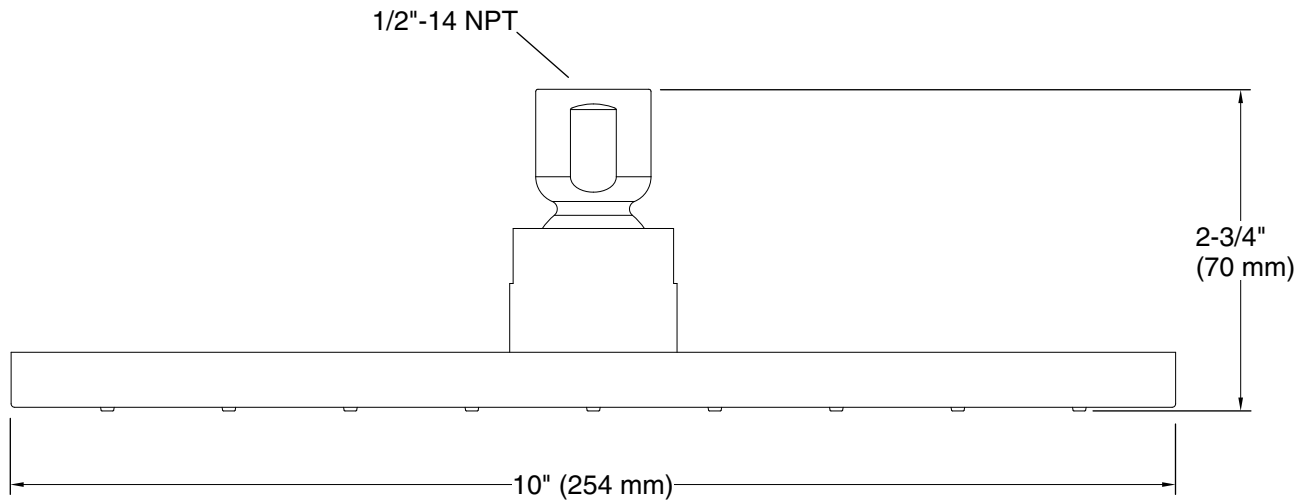

Technical Information

All product dimensions are nominal.

Notes

Install this product in accordance with the installation instructions.